

- LM-908 80x80x215cm
- LM-909 90x90x215cm
- LM-901 100x100x215cm

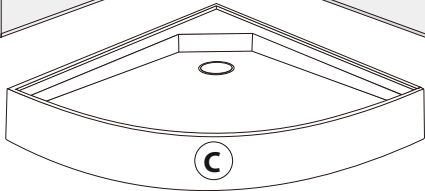

H1

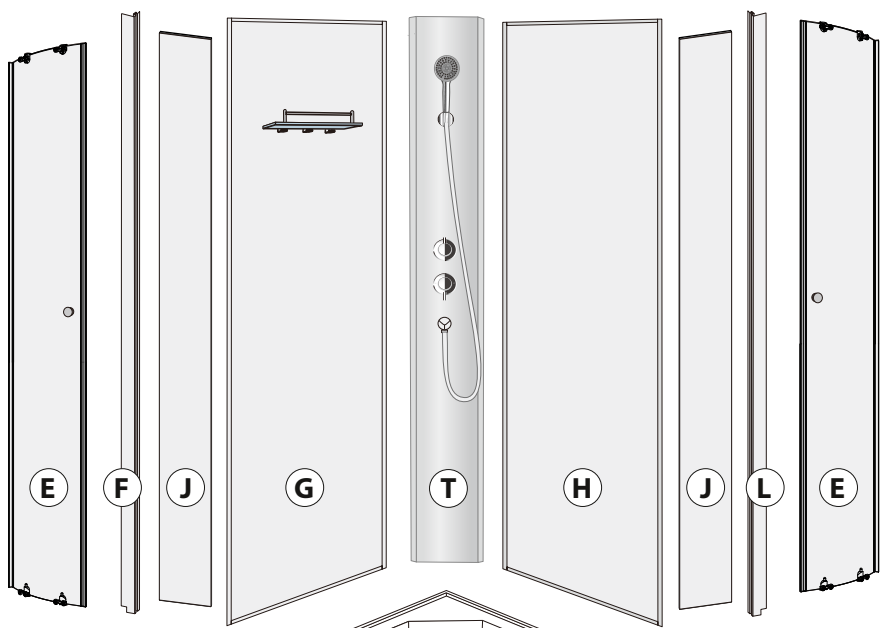
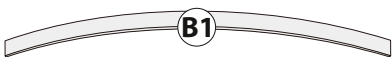
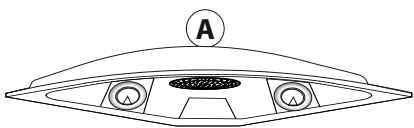

1820mm  
x2

H2

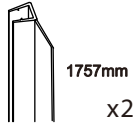

1757mm  
x2

H3



x8

H4



x2

H5

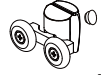

x4

H6



x4

H7

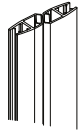

x1

H8



**St4x10**  
X16

H9



x1

H10



**M4x25**  
X2

H11



**St4x30**  
x8

H12



x4

H13



**St4x12**  
x4

H14



x4

H15



**St4x12**  
X8

H16

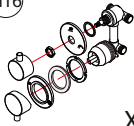

X1

H17



x1

H18



x2

H19



x1

H21

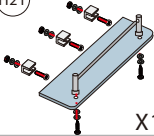

X1

H22



x1

H23



X1

H24



x2

H25

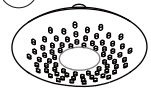

x1

H35

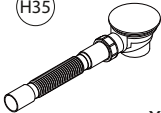

x1

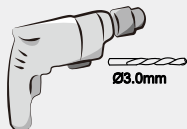
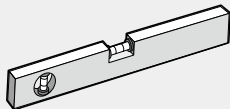
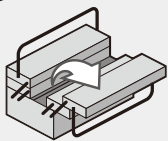

Ø3.0mm



1

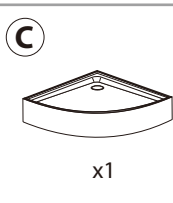
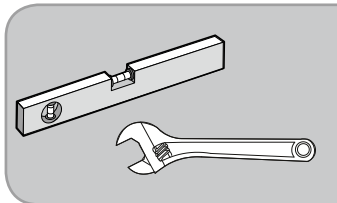
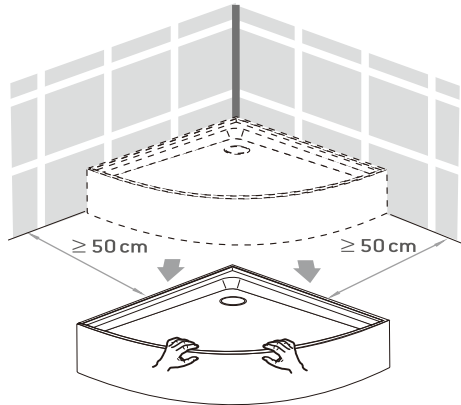
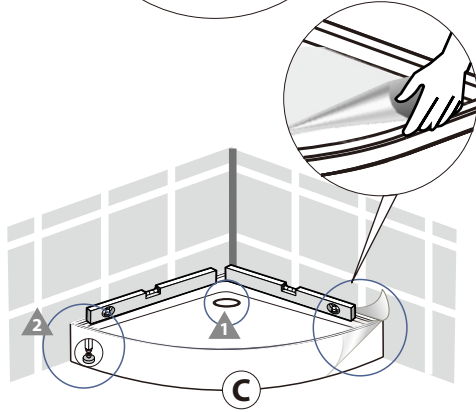
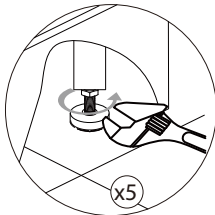
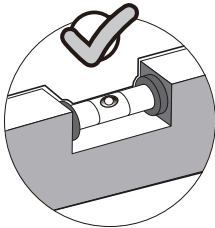
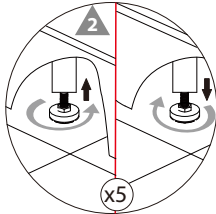
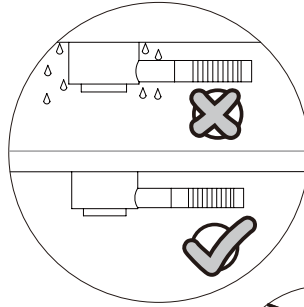
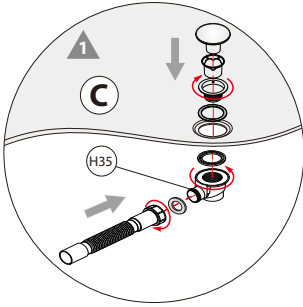

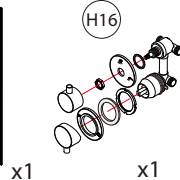
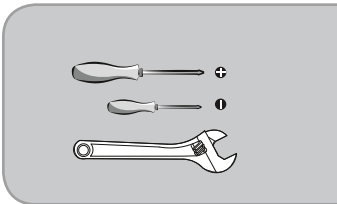
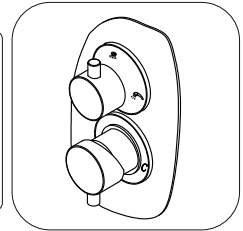
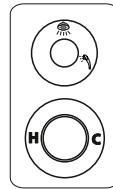
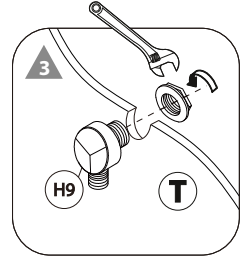
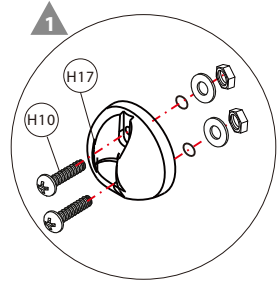
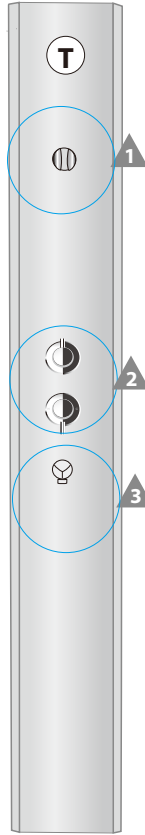
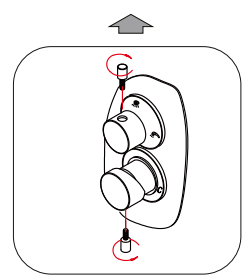
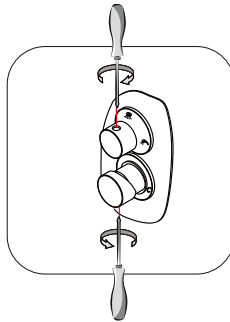
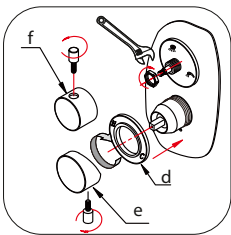
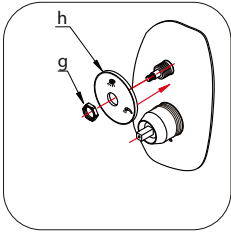
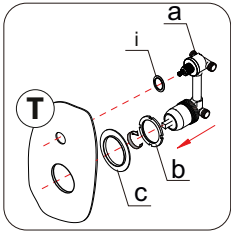
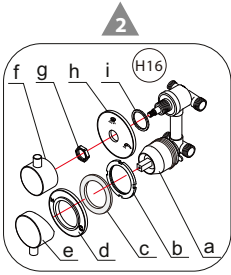

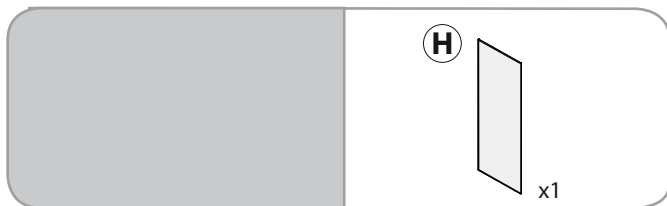
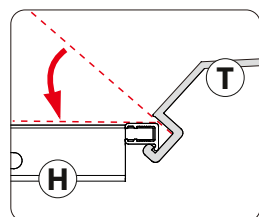
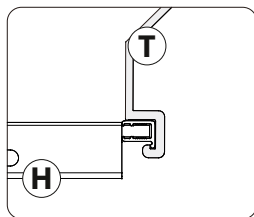
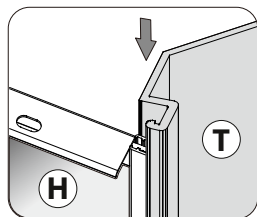
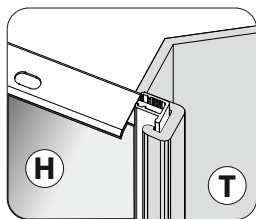
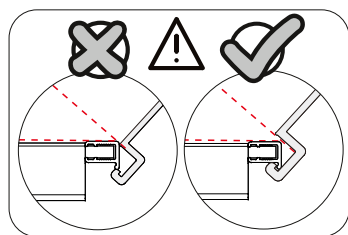
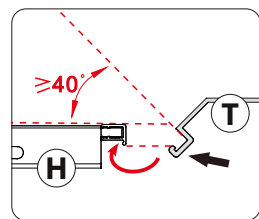
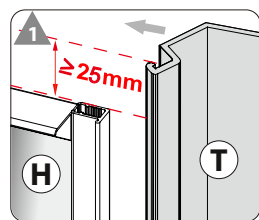
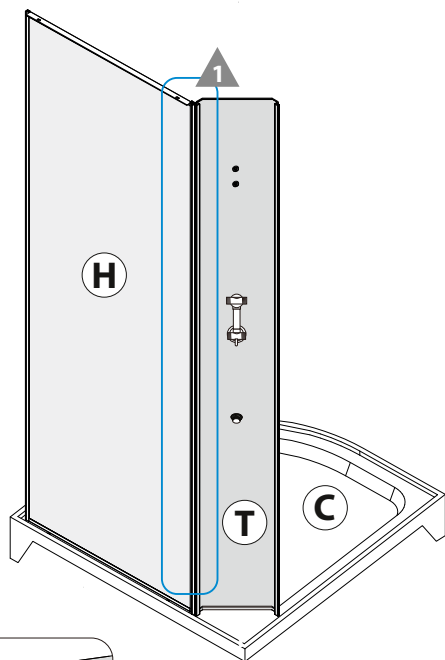

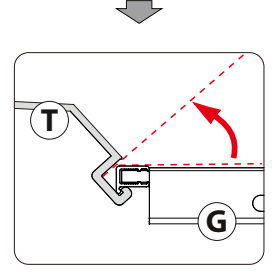
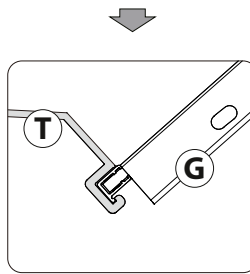
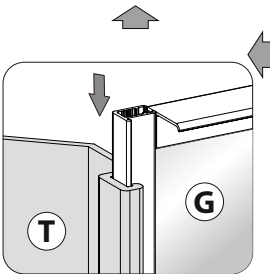
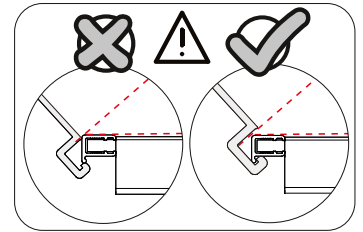
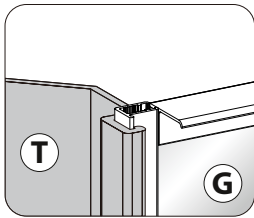
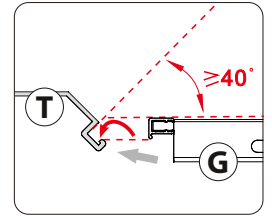
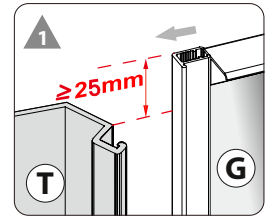
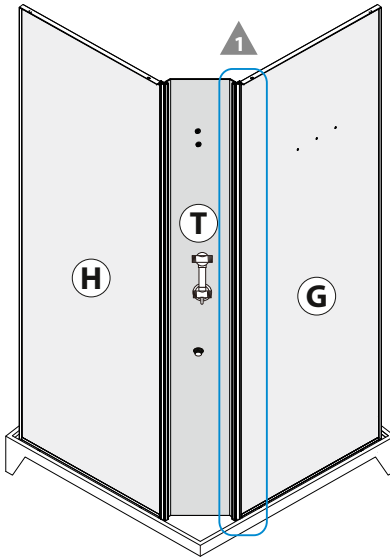

5

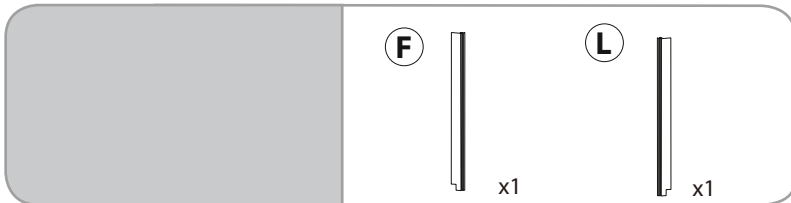
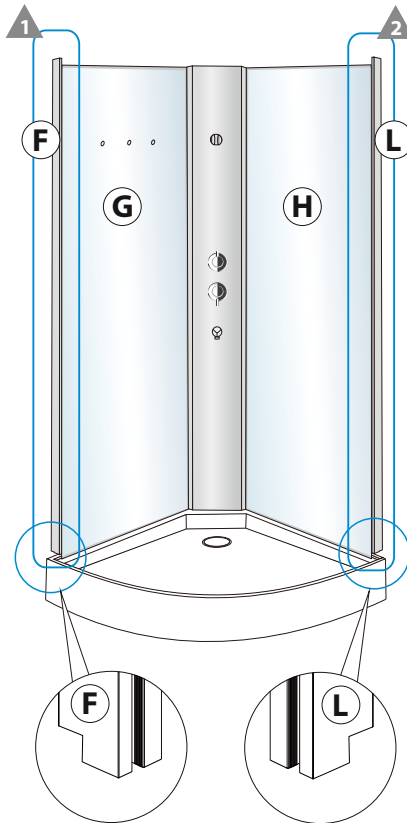
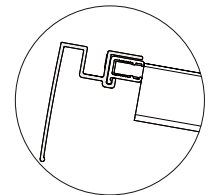
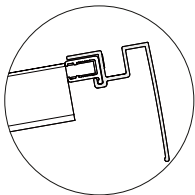
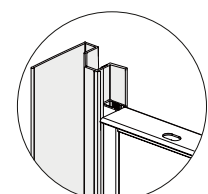
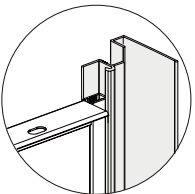
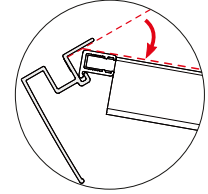
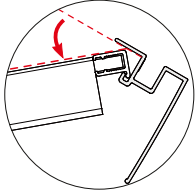
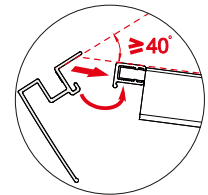
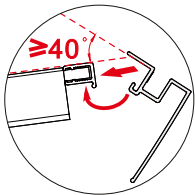
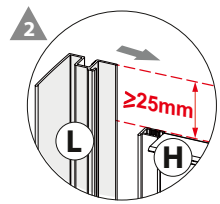
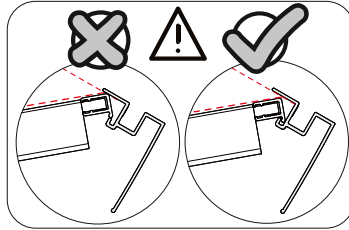
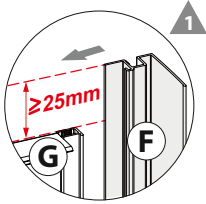



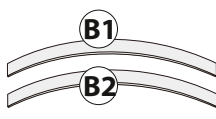
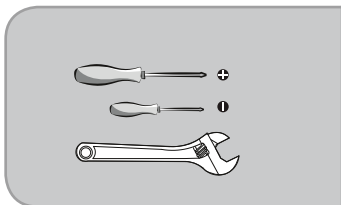
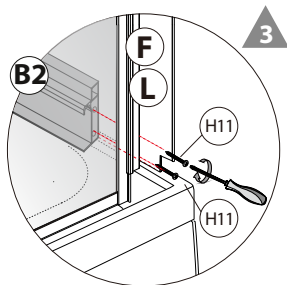
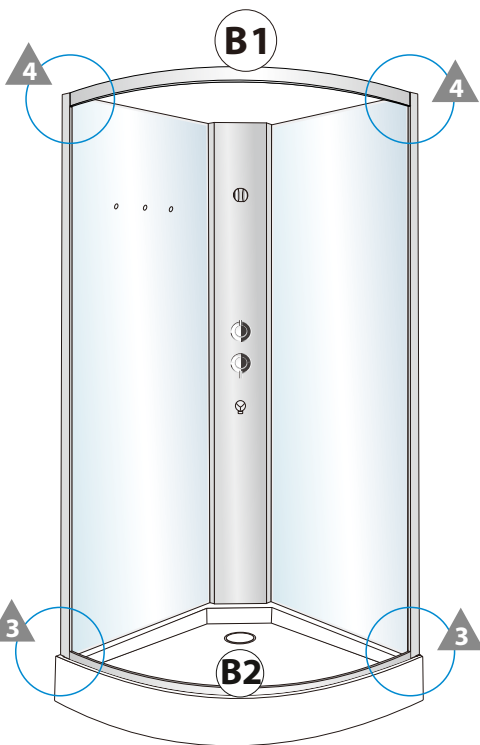
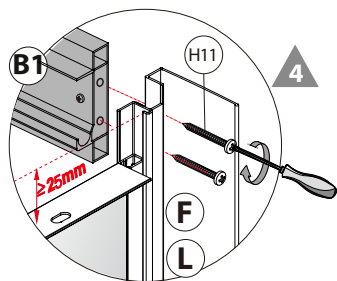
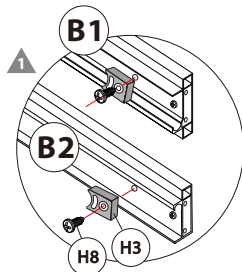
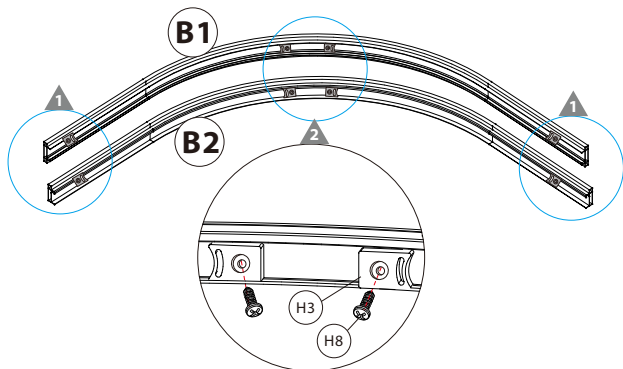

X1



X8



X8



X8

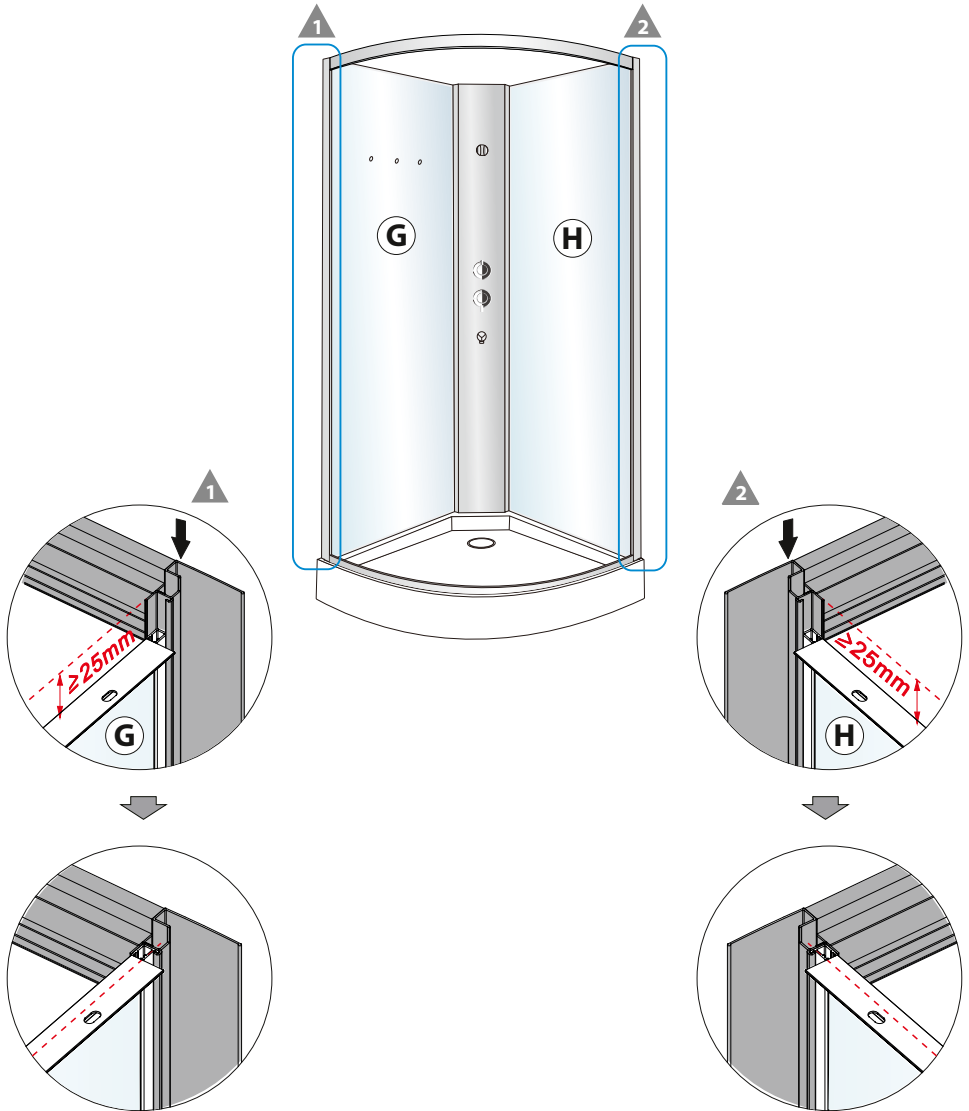

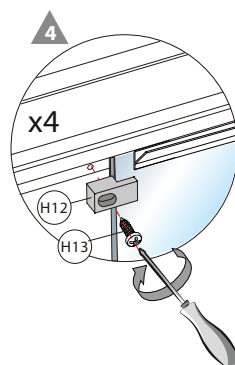
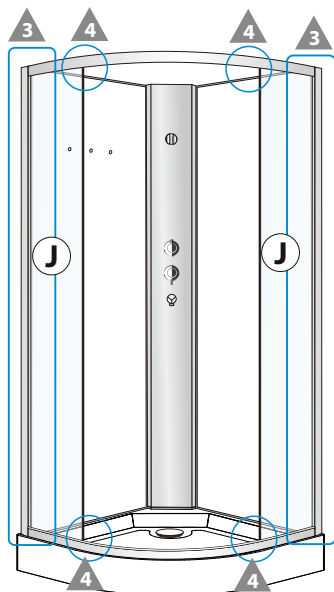
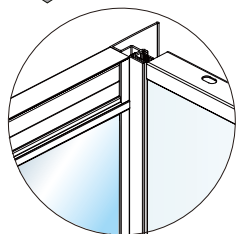
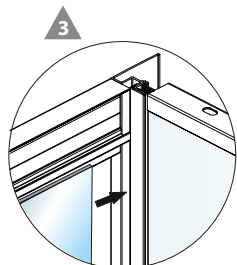
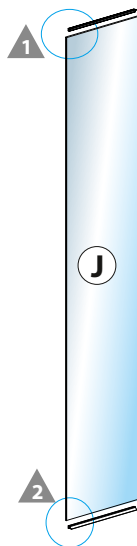
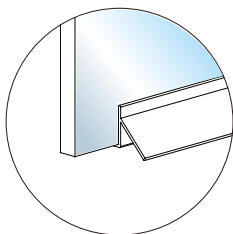
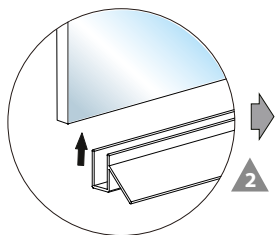
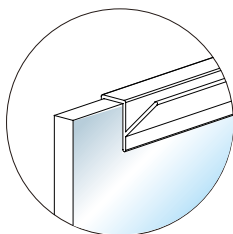
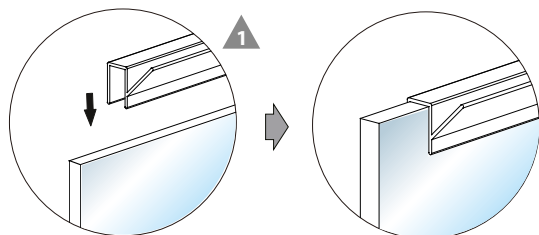

J



x2

H14



x4

H12



x4

H13



St4X12

x4

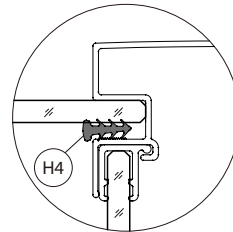
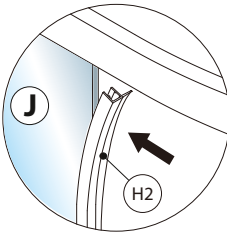
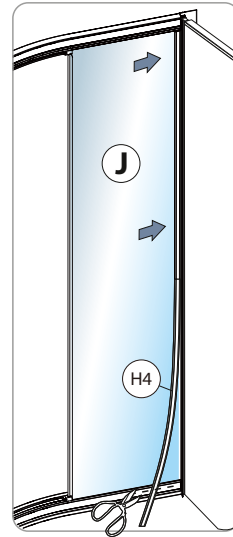
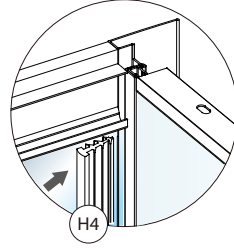
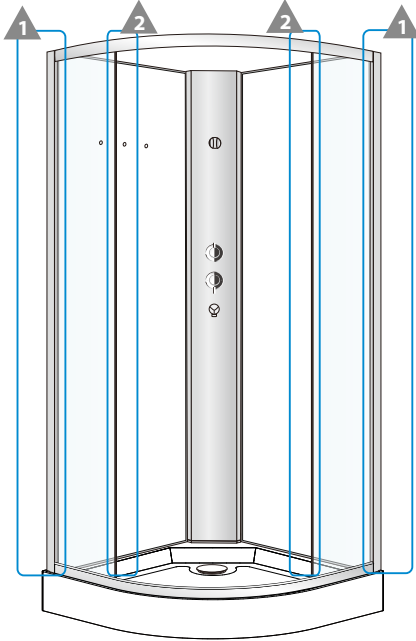

H4



X2

H2

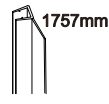

X2

2

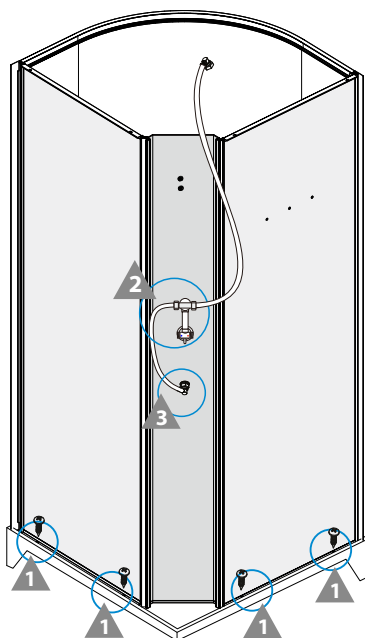
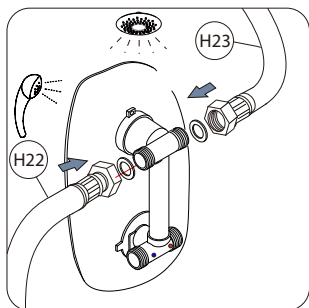

3

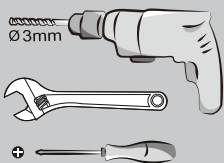
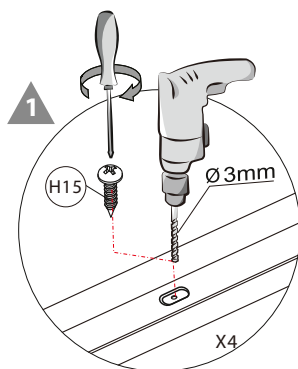
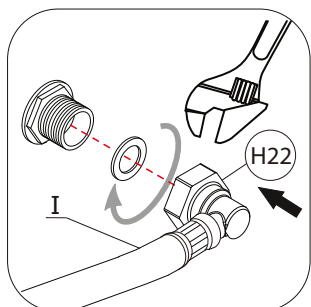

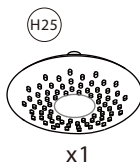
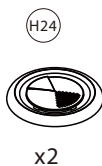
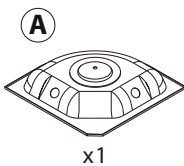
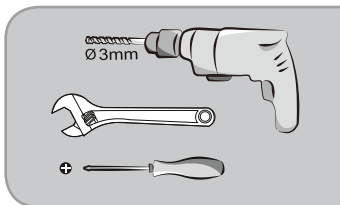
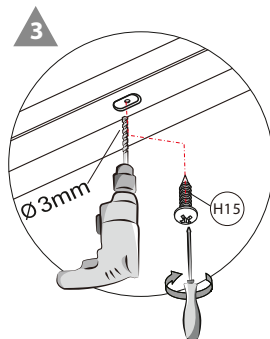
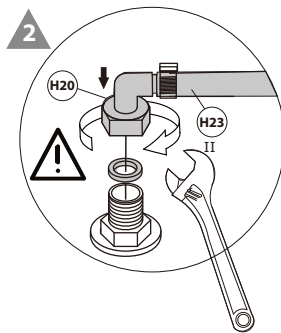
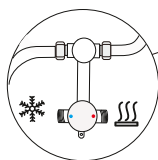
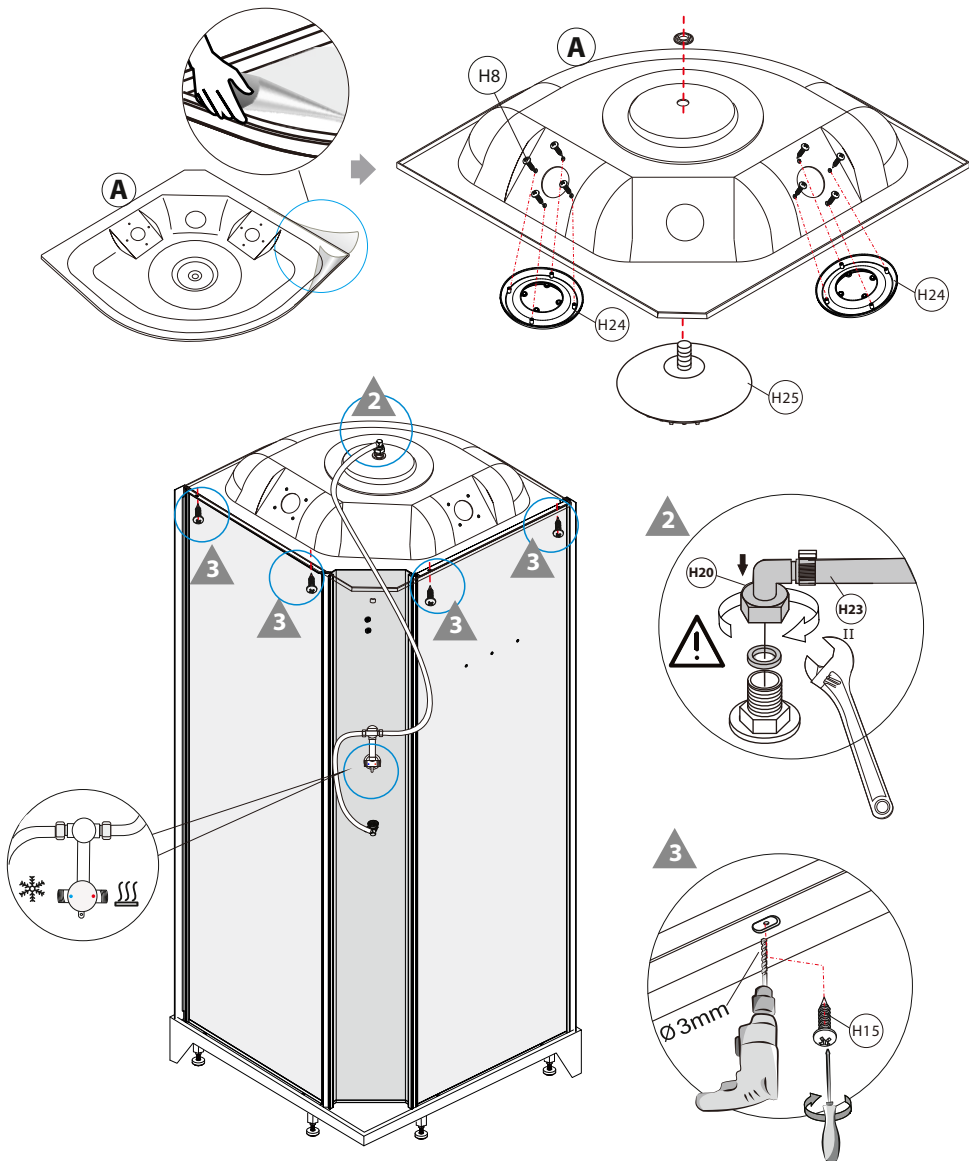

x1

x8

x2

x1

x4

